

Beyond the Tree

This 5" finished size ornament is made up of a portion of a Christmas Tree, a Star and a Candle. You can make each section and join them to make the complete ornament or you may enlarge them using Quilt Pro or EQ if you have those programs, and make them larger and use them individually. The sentiment behind the name is to let this ornament be a reminder of the Spirit of the Season. On another note, the star is 3" finished so it can be used in the Carol Doak Keepsake Cards

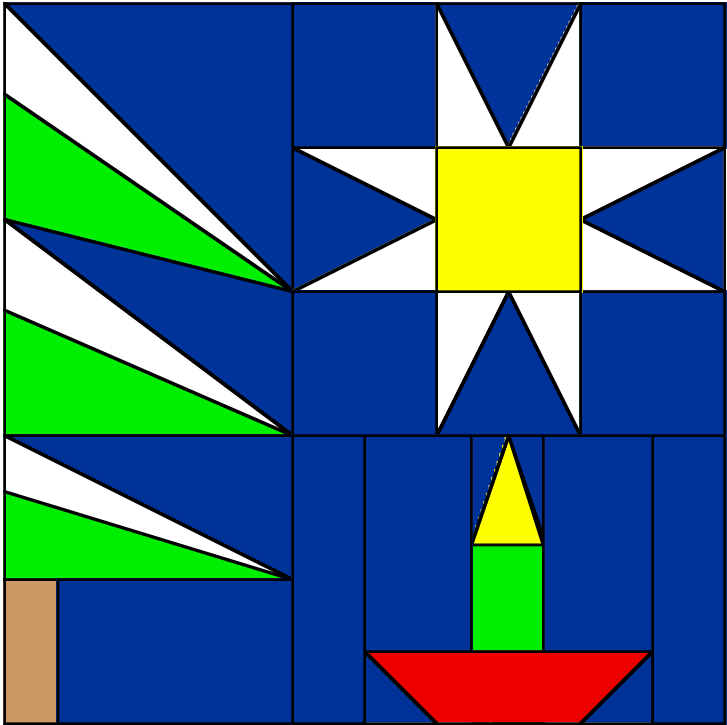

Finished Size 5" x 5"

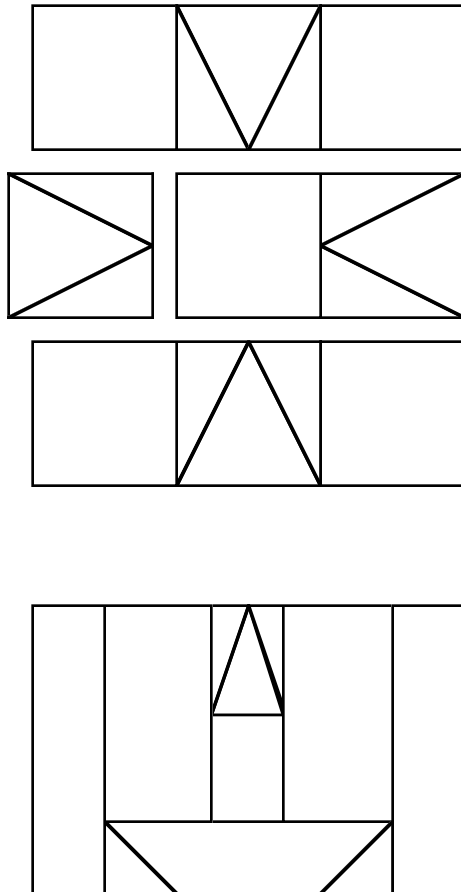
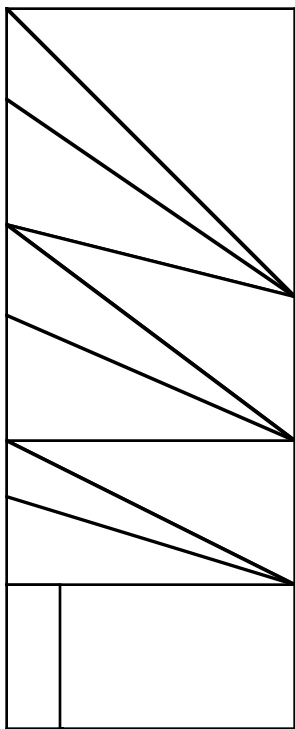

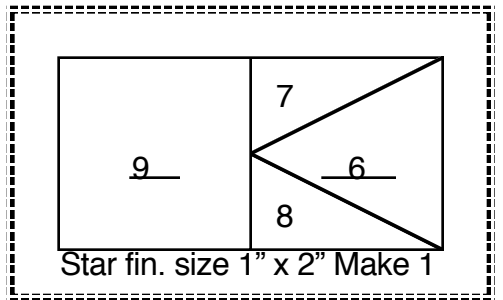
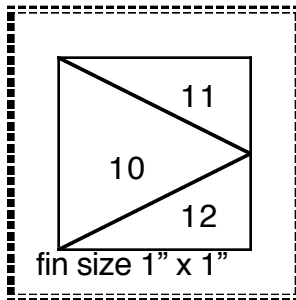
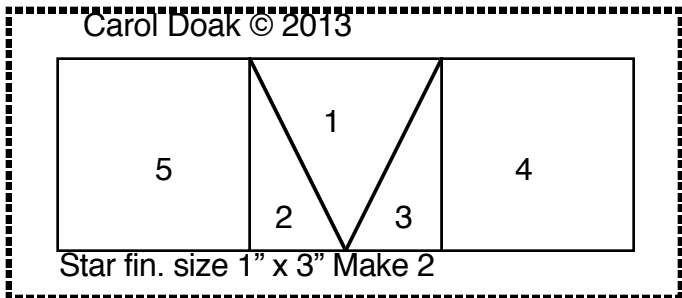
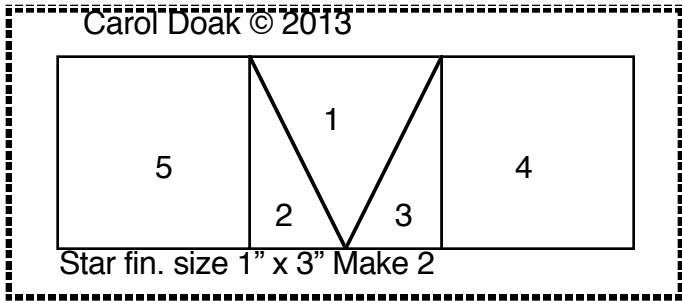
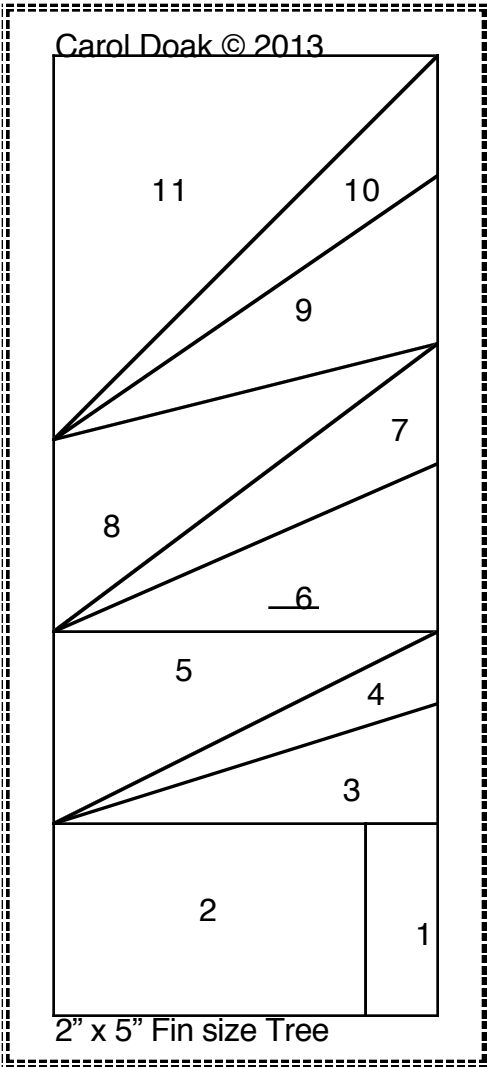

3" x 3" star when three rows are joined

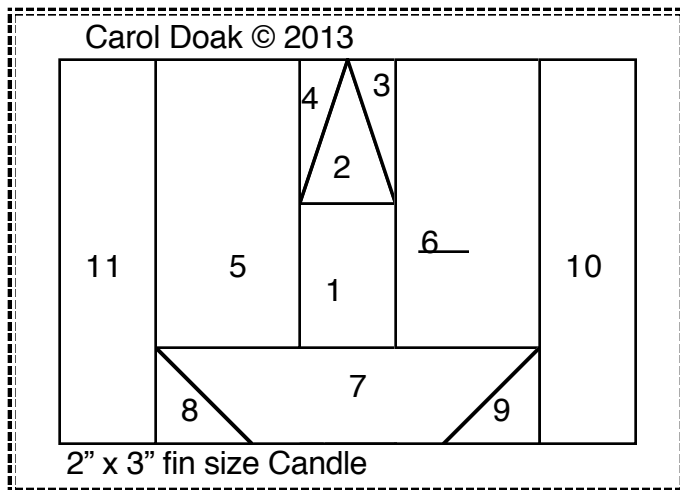

Cutting List

| Fabric | No. to Cut | Size to Cut | Location Nos. | Block |
|--------|------------|---------------------|--------------------|--------|
| Navy | 1 | 3 1/2" x 3 1/2" [/] | 11 | Tree |
| | 1 | 2" x 2" [/] | 8, 9 | Candle |
| | 1 | 1 3/4" x 2 1/2" | 2 | Tree |
| | 8 | 1 3/4" x 1 3/4" | 1, 4, 5, 6, 10 | Star |
| | 2 | 1 1/2" x 3 1/4" | 5, 8 | Tree |
| | 2 | 1 1/2" x 2 1/4" | 5, 6 | Candle |
| | 2 | 1 1/4" x 3" | 10, 11 | Candle |
| | 2 | 1" x 1 3/4" | 3, 4 | Candle |
| White | 3 | 1 1/4" x 3 1/2" | 4, 7, 10 | Tree |
| | 8 | 1" x 2" | 2, 3, 7, 8, 11, 12 | Star |
| Yellow | 1 | 1 3/4" x 1 3/4" | 9 | Star |
| | 1 | 1 1/4" x 1 1/2" | 2 | Candle |
| Brown | 1 | 1 3/4" x 2" | 1 | Tree |
| Red | 1 | 1 1/4" x 2 3/4" | 7 | Candle |
| Green | 3 | 1 1/2" x 3 1/4" | 3, 6, 9 | Tree |
| | 1 | 1 1/2" x 1 1/2" | 1 | Candle |

[/] indicates to cut the square and cut it once diagonally.